



## Quick Start Guide

ManageUPS<sup>®</sup> NET ADAPTER P-Series

ManageUPS<sup>®</sup> NET ADAPTER VP

ManageUPS DCU

DISCOVERY AND CONFIGURATION UTILITY

### Licenses and Trademarks

ManageUPS and MopUPS are registered trademarks of POWERVAR, Inc. All other trademarks, product and corporate names are the property of their respective owners.

Entire contents copyright ©2012 POWERVAR, Inc. All rights reserved.  
Reproduction in whole or in part without permission is prohibited.



## BEFORE YOU BEGIN

Internal ManageUPS adapters are powered from within the chassis of the UPS. For these adapter models, hardware installation must be completed before network and service settings can be configured in the adapter.

If an external ManageUPS adapter is powered up, it will function on a network even if it is not connected to a UPS.

In either case, there may be installation details specific to the particular UPS model family you are working with.

Review the ***Supplemental Installation Note*** that covers the specific UPS model you are working with before installing and configuring your ManageUPS adapter.



# MANAGEUPS

## QUICK START GUIDE

---

### Key Topics

The **Quick Start Guide** covers key topics at a minimal level of detail:

1. Configuring essential network settings
2. Configuring optional settings for various services
3. Applying option settings to multiple adapters
4. Using Filtered View

If you are installing a ManageUPS P-Series model, see section VII in the **User Guide and Reference** document for information on connecting the Environment Sensor to the ManageUPS Blue Bus connector.

If you need more information on any of the subject areas, try using the help resources provided in the ManageUPS WEB interface via the "?" link.

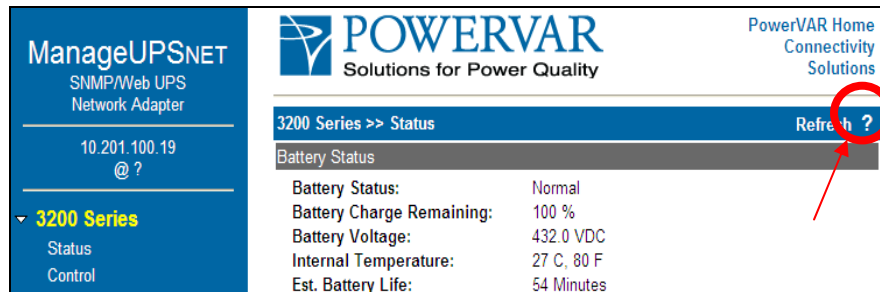

Further detail is also provided in the full **User Guide and Reference** document located at <http://connectivity.powervar.com>.

### Deploy First?

After you review this **Quick Start Guide**, you will realize that ManageUPS can be configured in a configuration lab and then deployed to a live network — or can be deployed first and configured later.

### Configure First?

### Your choice.

Generally, if your network does not use DHCP, and you need to deploy ManageUPS on a different network than the one that your workstation is connected to, you will need to configure ManageUPS first on a local network.

## Windows Workstation?

### ManageUPS DCU Discovery and Configuration Utility

The easiest way to get started is to use the *ManageUPS DCU* application from a Windows workstation connected to the same local network that ManageUPS is also connected.

To use this method, install ManageUPS DCU from the website.

Connect the ManageUPS adapter to the network.  
(see diagrams on pages 3 and 4)



**ManageUPS DCU** helps simplify initial configuration and ongoing management of ManageUPS adapters.

DCU installs on a Windows computer.

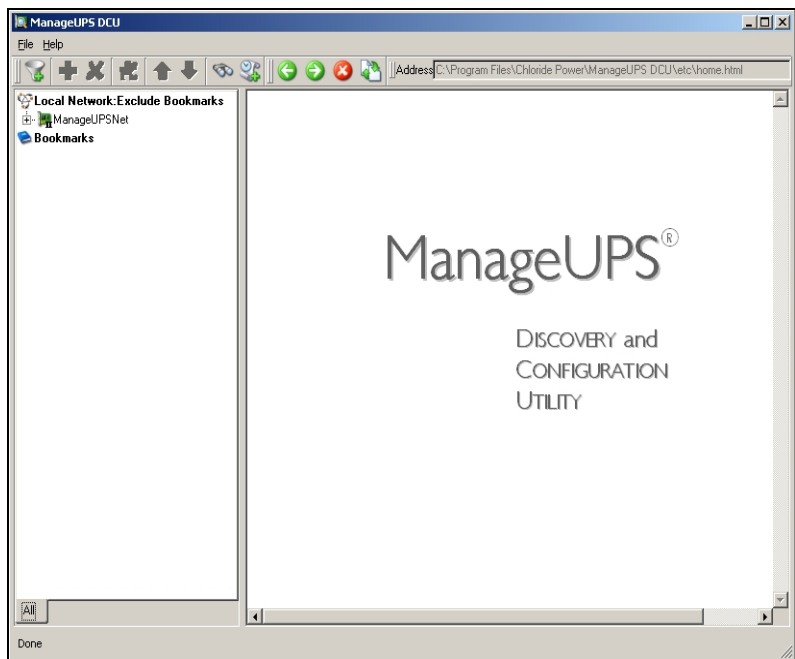

## Deploy First?

The simplified networking functions of ManageUPS adapters and DCU allow you to deploy adapters to remote locations first and configure them later via the network link.

### **AUTO-FIND ZONE:**

ManageUPS VP & ManageUPS P-Series adapters will present themselves to ManageUPS DCU automatically on the *local network*.

### **SEARCH ZONE:**

DCU has an efficient search mechanism that can be used to locate ManageUPS adapters connected to other networks.

To find adapters in the search zone, adapters must have valid IP addresses. Valid IP addresses may be assigned automatically by DHCP, or could be static IP addresses configured prior to deployment.

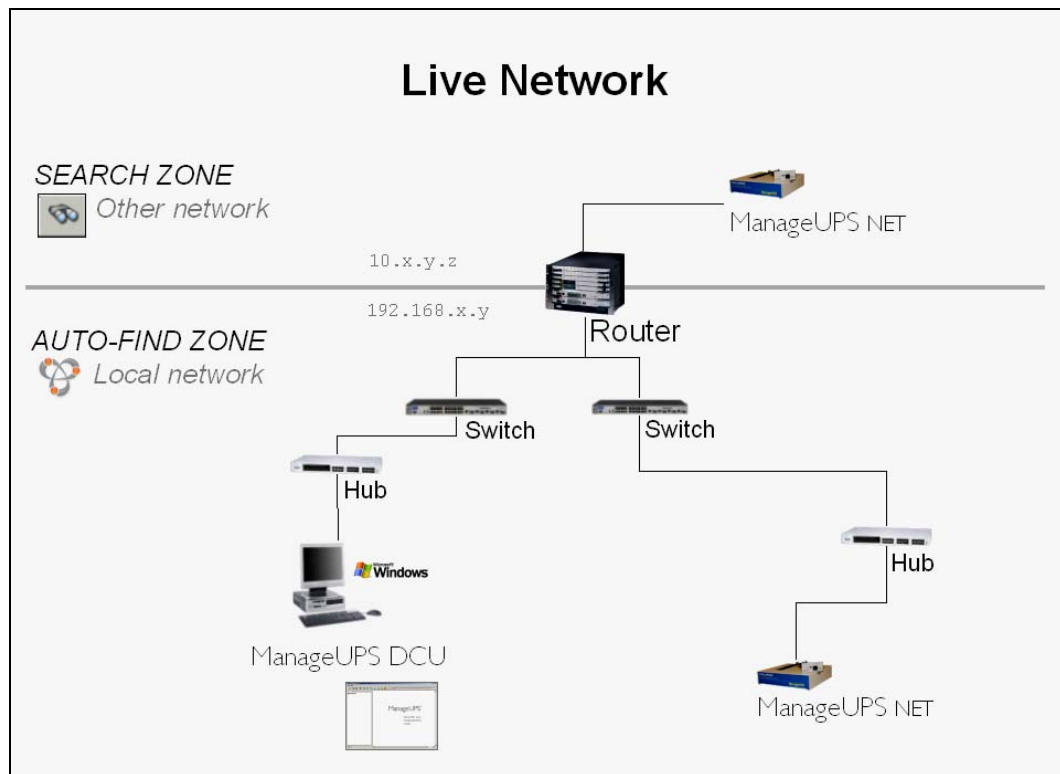

**NOTE:** If there is no DHCP server on the network that ManageUPS is connected to, ManageUPS will negotiate an IP address from the range reserved for Link-Local networking (169.254.xxx.xxx).

DCU will automatically add the link-local route to your Windows workstation in order to discover and connect to adapters connected to the local network. You must run DCU from a user account with Administrator rights.

However, link-local addresses are non-routable. DCU will not be able to find adapters on other networks (SEARCH ZONE) that have assumed link-local addresses.

## Configure First?

Configure first in a staging location and then deploy ...

Set up a simple configuration lab using an Ethernet crossover cable between ManageUPS and your DCU workstation's Ethernet adapter—or use a hub to create a stand-alone network.

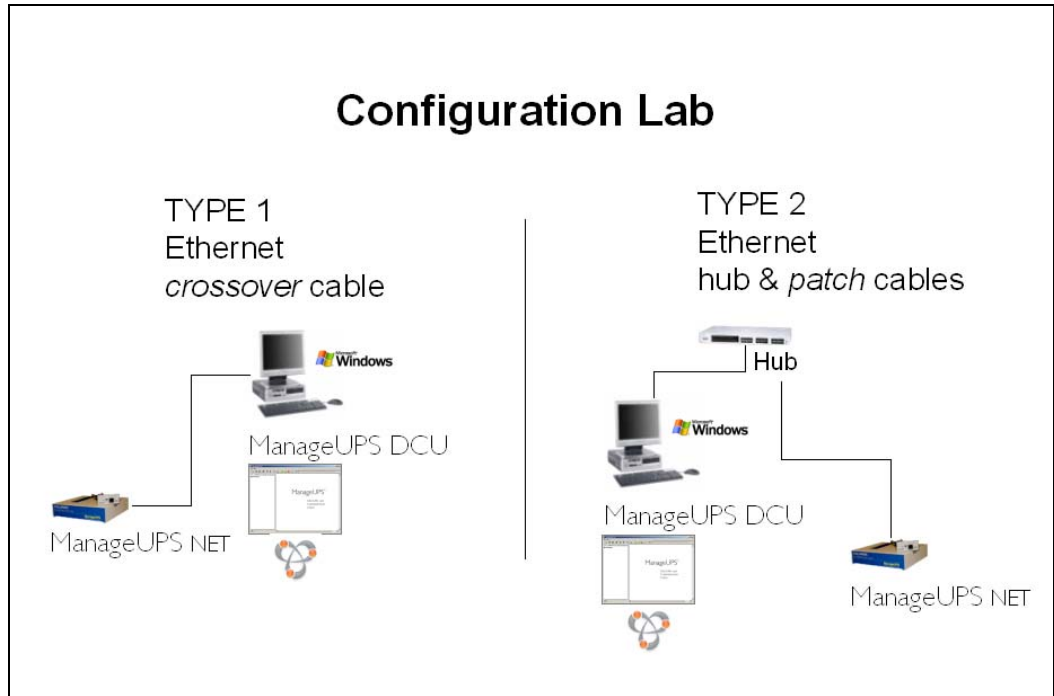

**NOTE:** If there is no DHCP server on your Local network, ManageUPS will negotiate an IP address from the range reserved for Link-Local networking (169.254.xxx.xxx).

DCU will automatically add the link-local route to your Windows workstation in order to discover and connect to adapters connected to the local network. You must run DCU from a user account with Administrator rights.

### Q. What is a Crossover Cable?

A crossover cable is used to make a direct connection between two network adapters. Some network adapters auto-sense the connection type and make the crossover adjustment without needing a crossover cable.

You can tell a crossover cable by comparing the pin mapping of the green and orange pairs with the chart below.



Cross-over cable

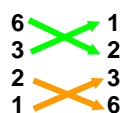

Patch cable

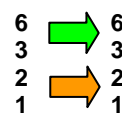



## Starting ManageUPS DCU

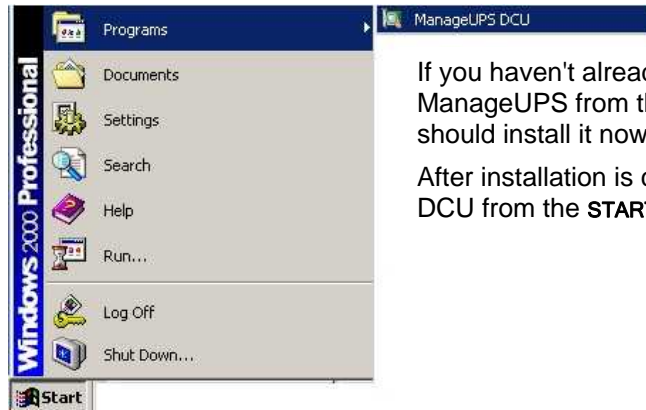

If you haven't already installed ManageUPS from the website you should install it now.

After installation is complete, launch DCU from the **START>>Programs** menu

## Navigation and Organization tools

If there are no ManageUPS adapters on the same network as your DCU workstation, the *NAVIGATION PANE* will be empty as shown below.

Adapters on the local network will appear in the *Local Network* tree (see inset) until you move the icon into the *Bookmarks* tree.

Left mouse-click either tree icon to bring a description of the navigation mechanism and display options to the *MAIN WINDOW*.

To find adapters on another network, left-mouse-click  the *Search* tool icon on the toolbar to open the IP-range search dialog. *Search* results will appear in the *Bookmarks* tree.

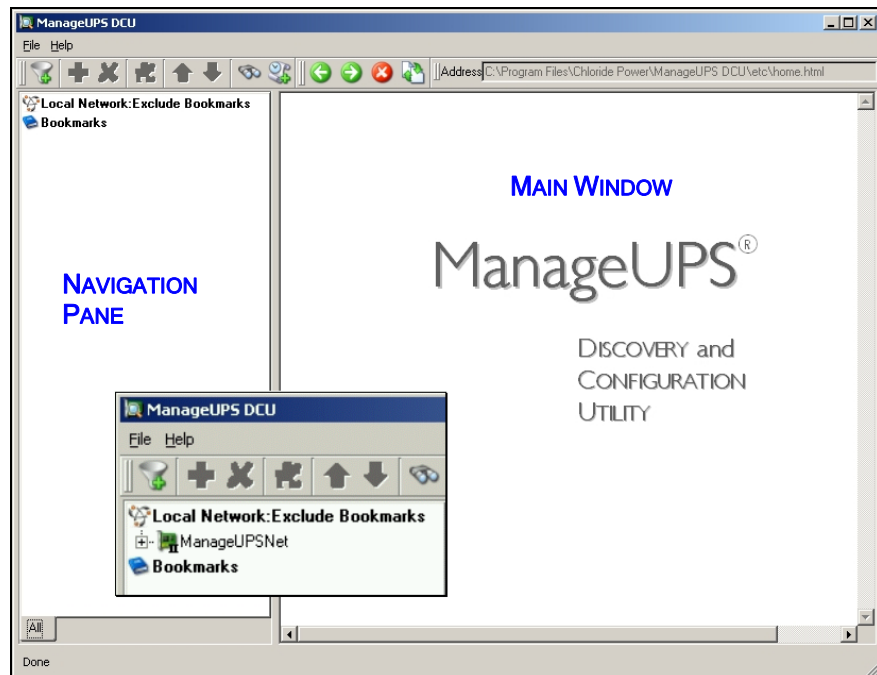

Left mouse-click the "+" to the left of an adapter icon to open the configuration navigation tree for that adapter.

## Configuring Essential Network Settings

The default ManageUPS network configuration mode accepts settings provided automatically by a DHCP server connected to the same network.

The first question to answer is whether ManageUPS will keep DHCP settings or will need fixed or "static" IP settings. Discuss this with the network administrator if you are not familiar with the network policy.

For more information on setting network parameters, use the ? help on the ManageUPS network settings WEB page or see **Section II: Network Setup** in the full **User Guide and Reference**.

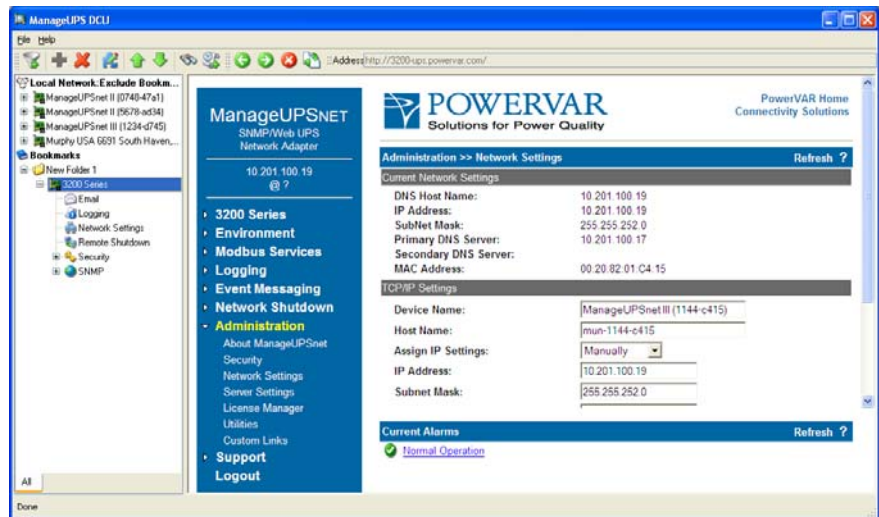

To access the dialog page for entering manual IP settings, select **Statically** from the drop down list box and press the **APPLY** button.

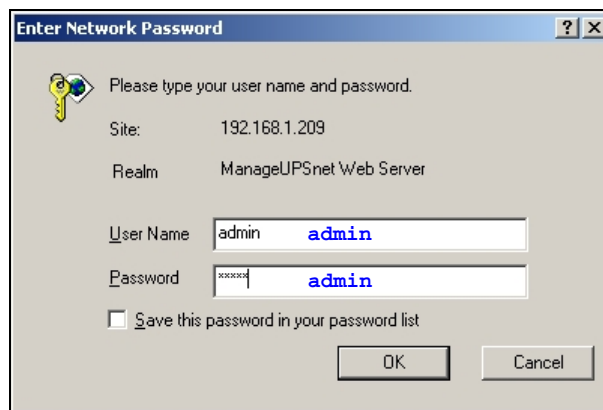

Before you can access ManageUPS, you will need to enter the *User Name* and *Password* combination.

The default entries are shown above. You can change these later in the **Security>>Passwords** dialog area.

## Configuring Service options

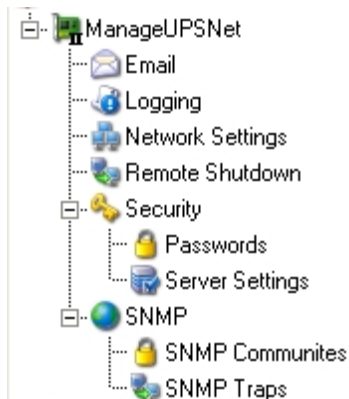

ManageUPS net adapter provides a variety of monitoring and management-related services for Uninterruptible Power Systems and associated auxiliary systems.

Navigation to the specific ManageUPS WEB pages that will be used to configure service options is simplified in the expanded device tree in the DCU navigation pane (left).

To become more familiar with these services and how to use them, refer to **Section I: About ManageUPS** and **Section III, Setting Service Options** in the full **User Guide and Reference** document.

*Some services require resources that are considered generally available on most networks. The table below identifies key variables and other considerations for each service.*

Service	Key Resources or Parameters
Event/Alarm messaging via <b>Email</b>	<p><b>E-mail destinations</b> the email addresses of where to send event/alarm messages</p> <p><b>SMTP Server:</b> DNS Name or IP address of SMTP server on the network that ManageUPS will use to route email.</p>
Data and/or Event <b>Logging</b>	<p><b>NTP (Time) Server</b> The default time reference for stamping log file entries is a time-server on the internet.</p> <p>If ManageUPS will not have internet access from the network it is connected to, ask your network administrator for the IP address or DNS name of a timeserver on your network.</p>
<b>Remote Shutdown (Network Shutdown) Controller</b>	<p><b>Shutdown Targets / Schedules / Delays</b> DNS names or IP address/range of servers or workstations on the network to be shutdown by ManageUPS in the event of extended AC outages</p> <p>Shutdown targets will need software (safe shutdown agent) installed that is compatible with ManageUPS. Some shutdown agents may require authentication credentials.</p> <p>You may also want to consider timing delays for various groups of servers or workstations.</p>
<b>SNMP</b>	<p><b>SNMP trap destinations:</b> (IP addresses) <b>SNMP communities:</b> (names, IP range and rights)</p>
<b>Security</b>	<p>HTTP, Telnet, FTP servers are active and use well-known ports by default.</p> <p>User Access settings determine read/write privileges and access password.</p> <p>See <b>Section VI, Administrative Settings</b> in the full <b>User Guide and Reference</b> document</p>

### Applying *Service Option* settings to multiple adapters

Once you have configured one adapter with SNMP, email or other service options, you can download the configuration file from the first adapter and upload it to other adapters.

To access the download dialog, press the download button  on the tool bar.

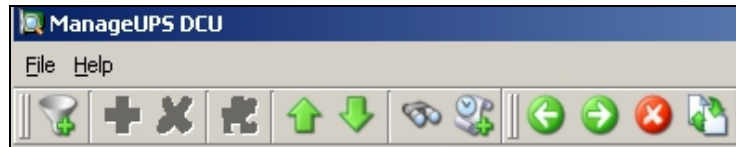

SNMP settings are held in a file named `snmp.conf`

All other *service options* are held in a file named `mopups.cfg`

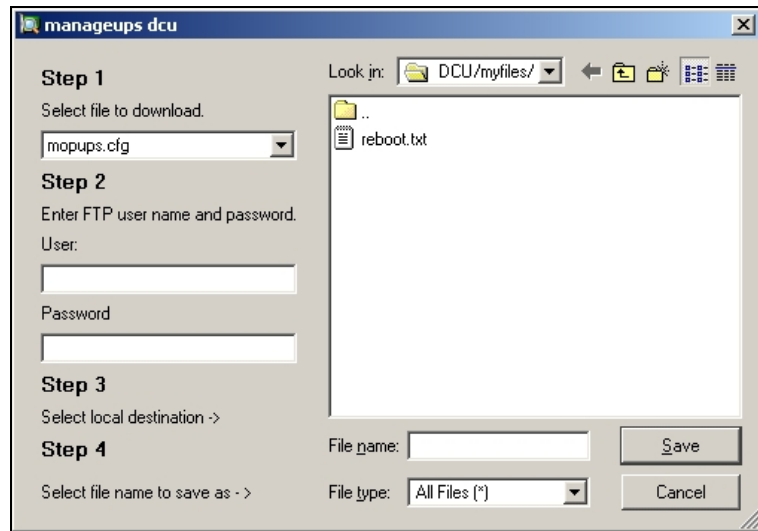

To access the upload dialog, press the upload button  on the tool bar.

Use the **File** button to access the file directory. Select the file you want to upload. Check the adapters in the **Targets** list that should receive the file. Check **Reboot after upload**. Press the **Upload** button.

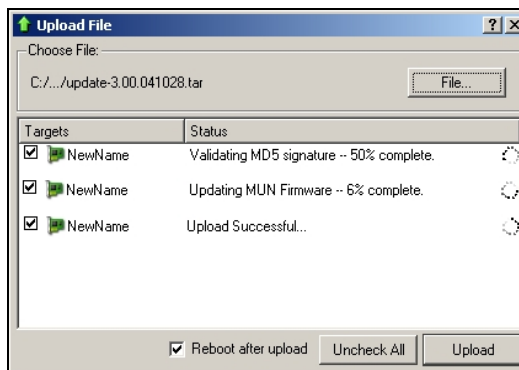

The **Upload** utility can also be used to update adapter firmware as well as upload settings and configuration files.

Press the  upload log view button on the DCU toolbar to view upload history.

See **Section VI, Administrative Settings** in the full *User Guide and Reference* document for more information on file function and maintenance

## Using Filtered View

**Filter View** creates a list of adapters in the *Bookmarks* tree that meet the filter criteria.

This can be useful in identifying new versus legacy ManageUPS adapters in a mixed population, or for identifying adapters that may not have the latest firmware or service option settings files.

Use the filter tool  on the DCU toolbar to access the filter dialog.

Select the type of adapter and/or upload file name and the upload date and press **OK**.

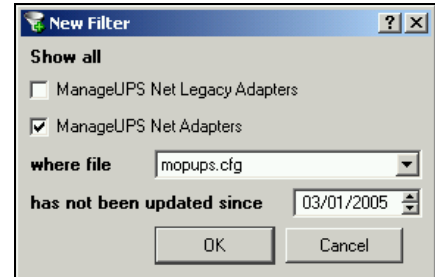

Access the filtered list result using the folder tab that appears at the bottom of the *Navigation Pane*.

